

Features

- Low On-Resistance
 - 53mΩ @V_{GS} = 4.5V
 - 104mΩ @V_{GS} = 2.5V
- Low Gate Threshold Voltage
- Low Input Capacitance
- Fast Switching Speed
- **Lead, Halogen and Antimony Free, RoHS Compliant (Note 1)**
- **"Green" Device (Note 2)**
- **Qualified to AEC-Q101 Standards for High Reliability**

Mechanical Data

- Case: SOT-23
- Case Material: Molded Plastic, "Green" Molding Compound. UL Flammability Classification Rating 94V-0
- Moisture Sensitivity: Level 1 per J-STD-020D
- Terminal Connections: See Diagram
- Terminals: Finish — Matte Tin annealed over Copper leadframe. Solderable per MIL-STD-202, Method 208
- Marking Information: See Page 3
- Ordering Information: See Page 3
- Weight: 0.008 grams (approximate)

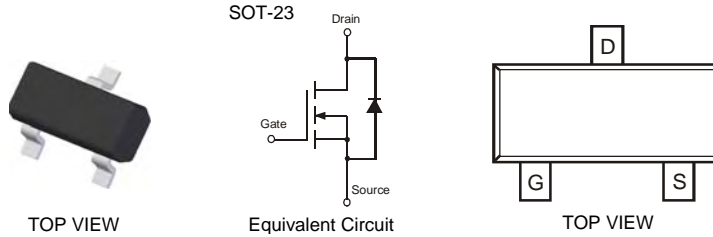

Maximum Ratings @T_A = 25°C unless otherwise specified

Characteristic	Symbol	Value	Units
Drain-Source Voltage	V _{DSS}	20	V
Gate-Source Voltage	V _{GSS}	±12	V
Drain Current (Note 3)	I _D	4.3	A
Pulsed Drain Current (Note 4)	I _{DM}	15	A

Thermal Characteristics

Characteristic	Symbol	Value	Units
Total Power Dissipation (Note 3)	P _D	1.4	W
Thermal Resistance, Junction to Ambient (Note 3)	R _{θJA}	90	°C/W
Operating and Storage Temperature Range	T _J , T _{STG}	-55 to +150	°C

Electrical Characteristics @T_A = 25°C unless otherwise specified

Characteristic	Symbol	Min	Typ	Max	Unit	Test Condition
OFF CHARACTERISTICS (Note 5)						
Drain-Source Breakdown Voltage	BV _{DSS}	20	—	—	V	V _{GS} = 0V, I _D = 250μA
Zero Gate Voltage Drain Current	I _{DSS}	—	—	500	nA	V _{DS} = 20V, V _{GS} = 0V
Gate-Source Leakage	I _{GSS}	—	—	±100	nA	V _{GS} = ±12V, V _{DS} = 0V
ON CHARACTERISTICS (Note 5)						
Gate Threshold Voltage	V _{GS(th)}	0.45	—	1.4	V	V _{DS} = V _{GS} , I _D = 250μA
Static Drain-Source On-Resistance	R _{DS(ON)}	—	42	53	mΩ	V _{GS} = 4.5V, I _D = 4.2A
			84	104		V _{GS} = 2.5V, I _D = 3.1A
Forward Transfer Admittance	Y _{fs}	—	6.6	—	S	V _{DS} = 5V, I _D = 4.2A
Diode Forward Voltage (Note 5)	V _{SD}	—	0.7	1.2	V	V _{GS} = 0V, I _S = 1.0A
DYNAMIC CHARACTERISTICS						
Input Capacitance	C _{iss}	—	325	—	pF	V _{DS} = 10V, V _{GS} = 0V f = 1.0MHz
Output Capacitance	C _{oss}	—	92	—	pF	
Reverse Transfer Capacitance	C _{rss}	—	70	—	pF	

- Notes:
1. No purposefully added lead. Halogen and Antimony Free.
 2. Diodes Inc.'s "Green" policy can be found on our website at http://www.diodes.com/products/lead_free/index.php.
 3. Device mounted on FR-4 PCB, on 2oz Copper pad layout with R_{θJA} = 90°C/W.
 4. Repetitive rating, pulse width limited by junction temperature.
 5. Short duration pulse test used to minimize self-heating effect.

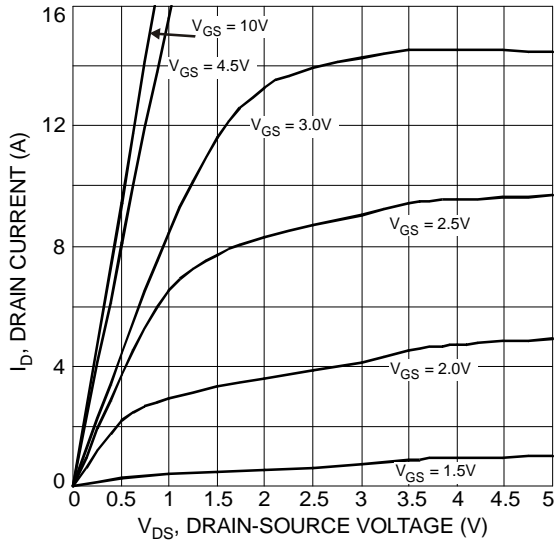

Fig. 1 Typical Output Characteristic

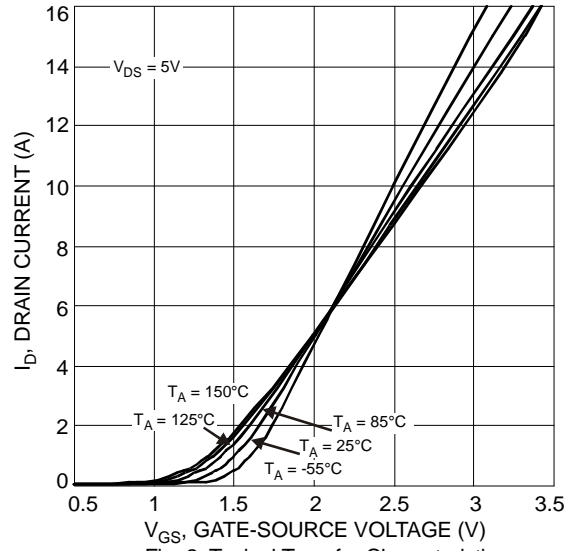

Fig. 2 Typical Transfer Characteristic

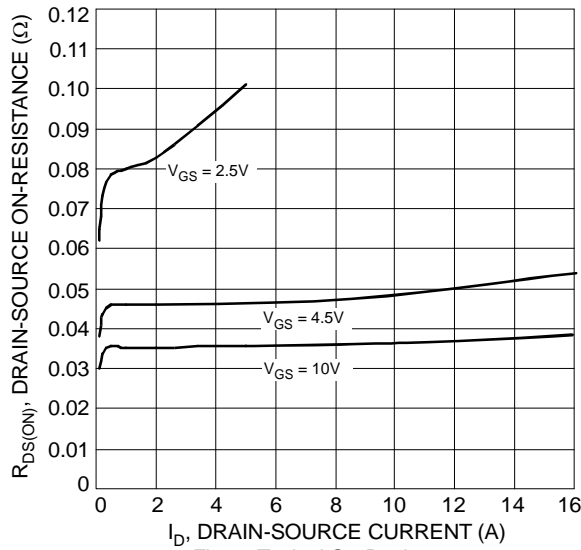

Fig. 3 Typical On-Resistance vs. Drain Current and Gate Voltage

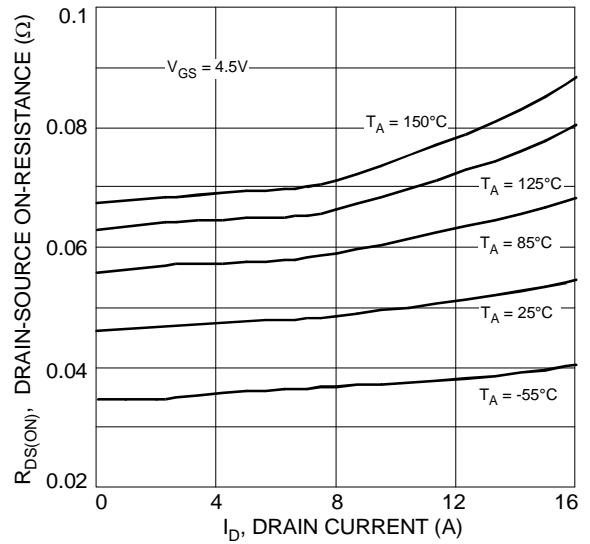

Fig. 4 Typical On-Resistance vs. Drain Current and Temperature

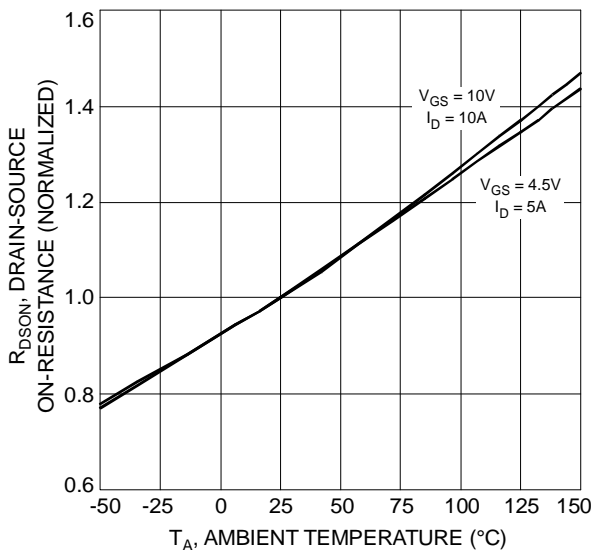

Fig. 5 On-Resistance Variation with Temperature

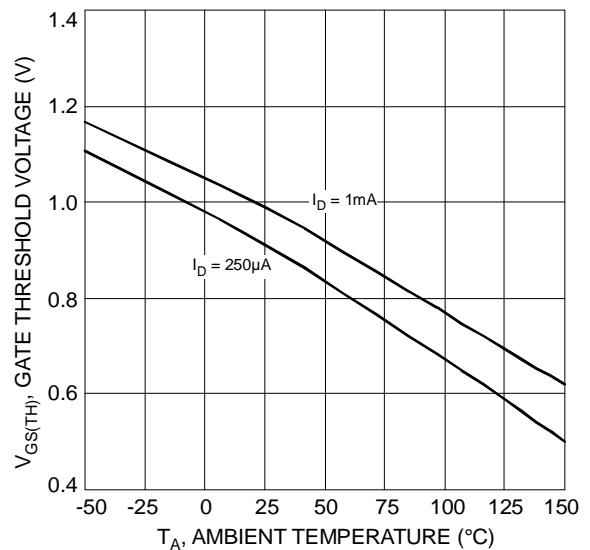

Fig. 6 Gate Threshold Variation vs. Ambient Temperature

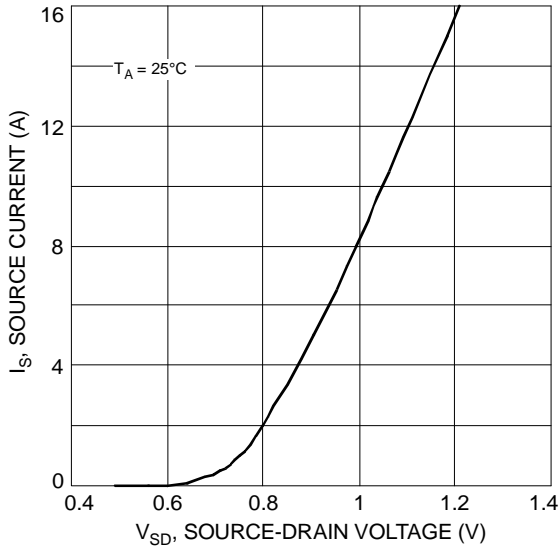

Fig. 7 Diode Forward Voltage vs. Current

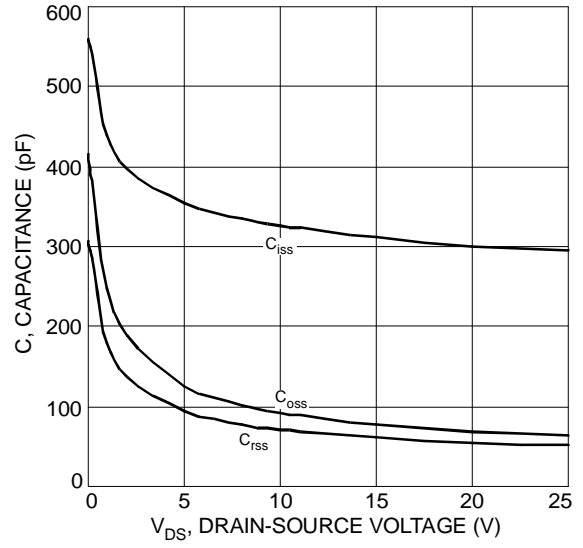

Fig. 8 Typical Total Capacitance

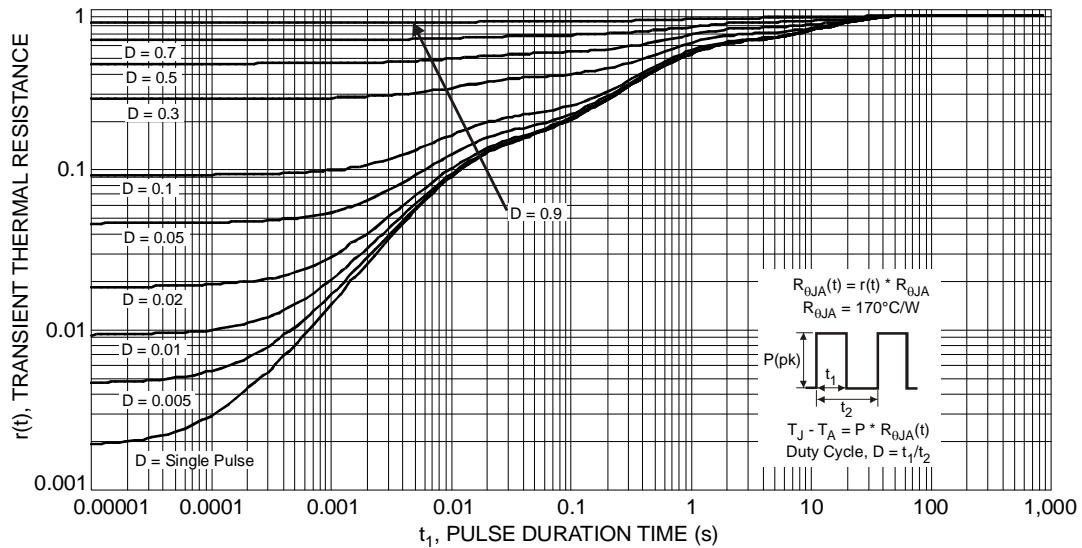

Fig. 9 Transient Thermal Response

Ordering Information (Note 7)

Part Number	Case	Packaging
DMN2104L-7	SOT-23	3000/Tape & Reel

Notes: 7. For packaging details, go to our website at <http://www.diodes.com/datasheets/ap02007.pdf>.

Marking Information

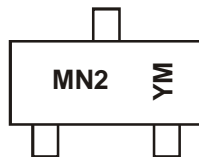

MN2 = Marking Code
YM = Date Code Marking
Y = Year (ex: V = 2008)
M = Month (ex: 9 = September)

Date Code Key

Year	2008	2009	2010	2011	2012	2013	2014	2015
Code	V	W	X	Y	Z	A	B	C

Month	Jan	Feb	Mar	Apr	May	Jun	Jul	Aug	Sep	Oct	Nov	Dec
Code	1	2	3	4	5	6	7	8	9	O	N	D

Package Outline Dimensions

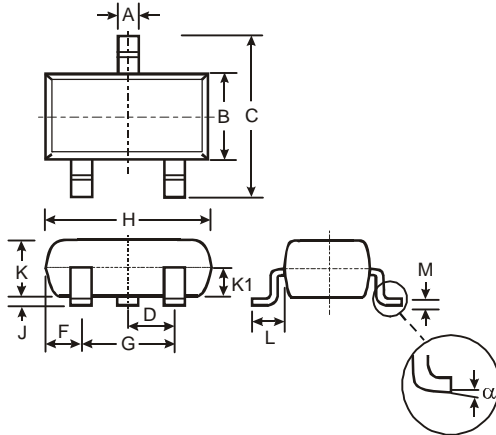

SOT-23			
Dim	Min	Max	Typ
A	0.37	0.51	0.40
B	1.20	1.40	1.30
C	2.30	2.50	2.40
D	0.89	1.03	0.915
F	0.45	0.60	0.535
G	1.78	2.05	1.83
H	2.80	3.00	2.90
J	0.013	0.10	0.05
K	0.903	1.10	1.00
K1	-	-	0.400
L	0.45	0.61	0.55
M	0.085	0.18	0.11
α	0°	8°	-
All Dimensions in mm			

Suggested Pad Layout

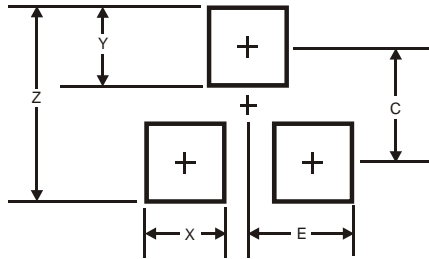

Dimensions	Value (in mm)
Z	2.9
X	0.8
Y	0.9
C	2.0
E	1.35

IMPORTANT NOTICE

Diodes Incorporated and its subsidiaries reserve the right to make modifications, enhancements, improvements, corrections or other changes without further notice to any product herein. Diodes Incorporated does not assume any liability arising out of the application or use of any product described herein; neither does it convey any license under its patent rights, nor the rights of others. The user of products in such applications shall assume all risks of such use and will agree to hold Diodes Incorporated and all the companies whose products are represented on our website, harmless against all damages.

LIFE SUPPORT

Diodes Incorporated products are not authorized for use as critical components in life support devices or systems without the expressed written approval of the President of Diodes Incorporated.